

Rotary Screw Compressors CSD / CSDX Series

With the world-renowned SIGMA PROFILE 

Flow rate from 1.05 to 16.95 m³/min, Pressure 5.5 to 15 bar



CSD(X) series

CSD/CSDX – Setting the standard

KAESER KOMPRESSOREN pushes the boundaries of compressed air efficiency once again with its latest generation of CSD and CSDX series rotary screw compressors. The value-added user benefits are immediately apparent just by taking a quick glance at the the completely redesigned compressor enclosure.

CSD/CSDX – Quadruple savings

These versatile rotary screw compressor ranges provide significant energy savings in four ways: Firstly, low speed SIGMA PROFILE airends equipped with flow-optimised rotors have enabled specific power to be reduced by up to six percent compared with previous models. Secondly, the use of IE3 drive motors maximises energy efficiency (use of these motors became mandatory in the EU from the 1st of January 2015). Thirdly, KAESER's 1:1 drive design eliminates the transmission losses associated with gear or V-belt driven systems, as the motor directly drives the airend. Fourthly, the SIGMA CONTROL 2 compressor controller enables compressor performance to be precisely matched to actual air demand thereby allowing additional energy savings.

Ease of maintenance ensures savings

The distinctive and eye-catching design of these systems from the outside is complemented by intelligent component layout on the inside for even greater energy efficiency: All service and maintenance points are within easy reach and are directly accessible from the front of the unit.

Potential energy cost savings with heat recovery

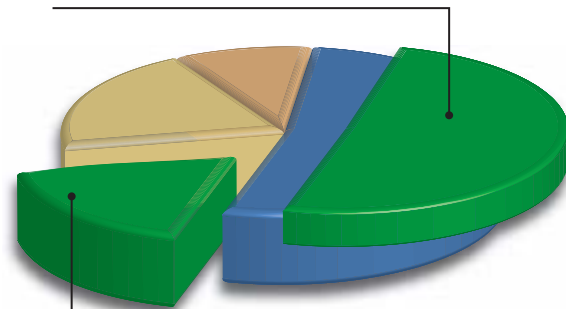

Energy cost savings through system optimisation

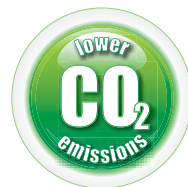

- Compressed air system investment
- Maintenance costs
- Energy costs
- Potential energy cost savings

Perfect partners

CSD and CSDX series rotary screw compressors are the perfect choice for high efficiency compressed air systems in industrial settings. The internal SIGMA CONTROL 2 compressor controller offers numerous communication channels, which allows seamless communication with advanced master controllers, such as KAESER's SIGMA AIR MANAGER, and in-house centralised control systems. This enables simple set-up and achieves unprecedented levels of efficiency.

Electronic Thermal Management (ETM)

Powered via an electric motor, the sensor-controlled temperature control valve integrated into the cooling circuit is the heart of the innovative Electronic Thermal Management (ETM) system. The new SIGMA CONTROL 2 compressor controller monitors intake and compressor temperature in order to prevent condensate formation, even with differing air humidity conditions. ETM dynamically controls the fluid temperature - low fluid temperature enhances energy efficiency. This system also enables end users to better adapt heat recovery systems to suit their specific needs.

Service-friendly



Image: CSD 125 T SFC

CSD(X) series

KAESER quality and efficiency for every need



SIGMA PROFILE airrend

At the heart of every CSD/CSDX system lies a premium quality air end featuring KAESER's SIGMA PROFILE rotors. Operating at low speed, KAESER's airrends are equipped with flow-optimised rotors for superior efficiency.



SIGMA CONTROL 2

The SIGMA CONTROL 2 ensures efficient control and system monitoring. The large display and RFID reader provide effective communication and maximum security. Multiple interfaces offer exceptional flexibility, whilst the SD card slot makes updates quick and easy.



Maximum efficiency: IE3 motors

Long before the use of IE3 motors became mandatory in the EU on the 1st of January 2015, users could already enjoy the benefits that these premium efficiency motors have to offer by choosing KAESER compressors.



Electronic Thermal Management

The innovative Electronic Thermal Management (ETM) system dynamically controls fluid temperature to provide reliable prevention of condensate accumulation. This enhances energy efficiency, for example, by enabling heat recovery to be precisely tailored to meet customers' exact needs.

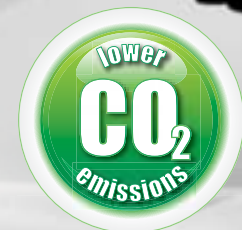
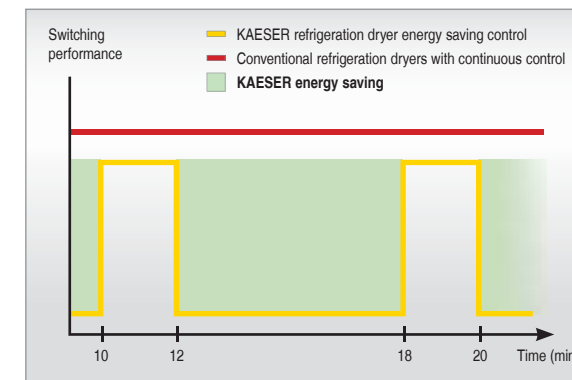

Image: CSD 125 T

Lubrication point for drive motor and fan motor

CSD(X) T series

Premium compressed air quality with an integrated refrigeration dryer



Energy-saving control

The integrated refrigeration dryer in CSD(X)-T units provides high-efficiency performance thanks to its energy-saving control. The dryer is therefore active only when compressed air actually needs to be dried: As a result, this approach achieves the required compressed air quality with maximum efficiency.



Dependable centrifugal separator

A KAESER axial centrifugal separator fitted with an electronic ECO-DRAIN condensate drain installed upstream from of the refrigeration dryer ensures that condensate is reliably pre-separated and drained, even when ambient temperatures and humidity are high.



Dual cooling

Two independent fans and a separate enclosure ensure high thermal reserve for the integrated refrigeration dryer. This allows the required compressed air quality to be reliably maintained at all times even at high ambient temperatures.

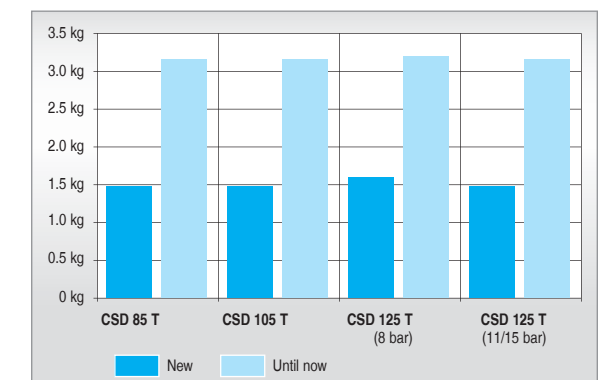

Minimal refrigerant required

The refrigeration dryers in Kaeser's new CSD(X)-T units require approximately fifty percent less refrigerant than conventional dryers. This not only saves costs, but is also significantly more environmentally compatible.

CSD(X) SFC series

Variable speed control perfected



Lubrication point for drive motor and fan motor

Image: CSDX 165 SFC

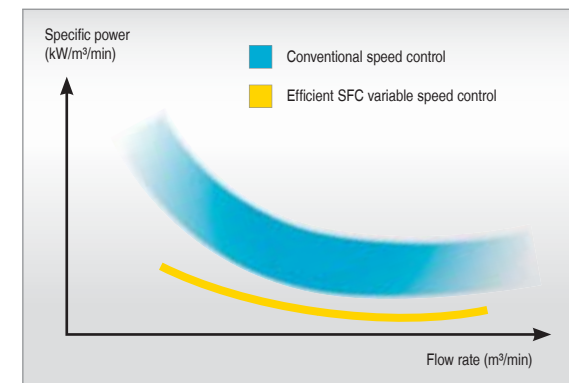

Optimised specific power

In any compressed air installation, it is the variable speed controlled compressor that operates longer than any other unit within the system. CSD(X)-SFC models were therefore built with maximum efficiency in mind and are designed to avoid extreme high speed operation. This saves energy, maximises service life and enhances reliability.



Separate SFC control cabinet

KAESER's variable speed SFC packages are equipped with Siemens frequency converters. They provide seamless communication between the SFC control cabinet and the compressor controller, thereby ensuring maximum efficiency at all times.

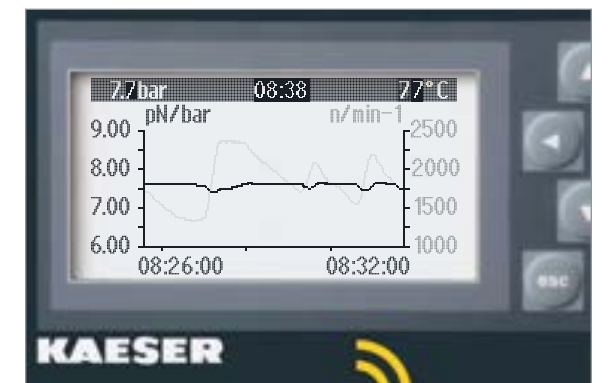

Pressure always in view

Operating pressure can be consistently maintained within ± 0.1 bar. In turn, the consequent ability to reduce maximum system pressure also reduces energy costs. The relationship between pressure consistency and speed can be viewed directly on the SIGMA CONTROL 2 display.



Zero Interference

The SFC control cabinet and SIGMA CONTROL 2 are Class A1 tested and certified as per electromagnetic compatibility regulation EN 55011, both as individual components and as an integrated system.

CSD(X) series

Use heat, reduce costs

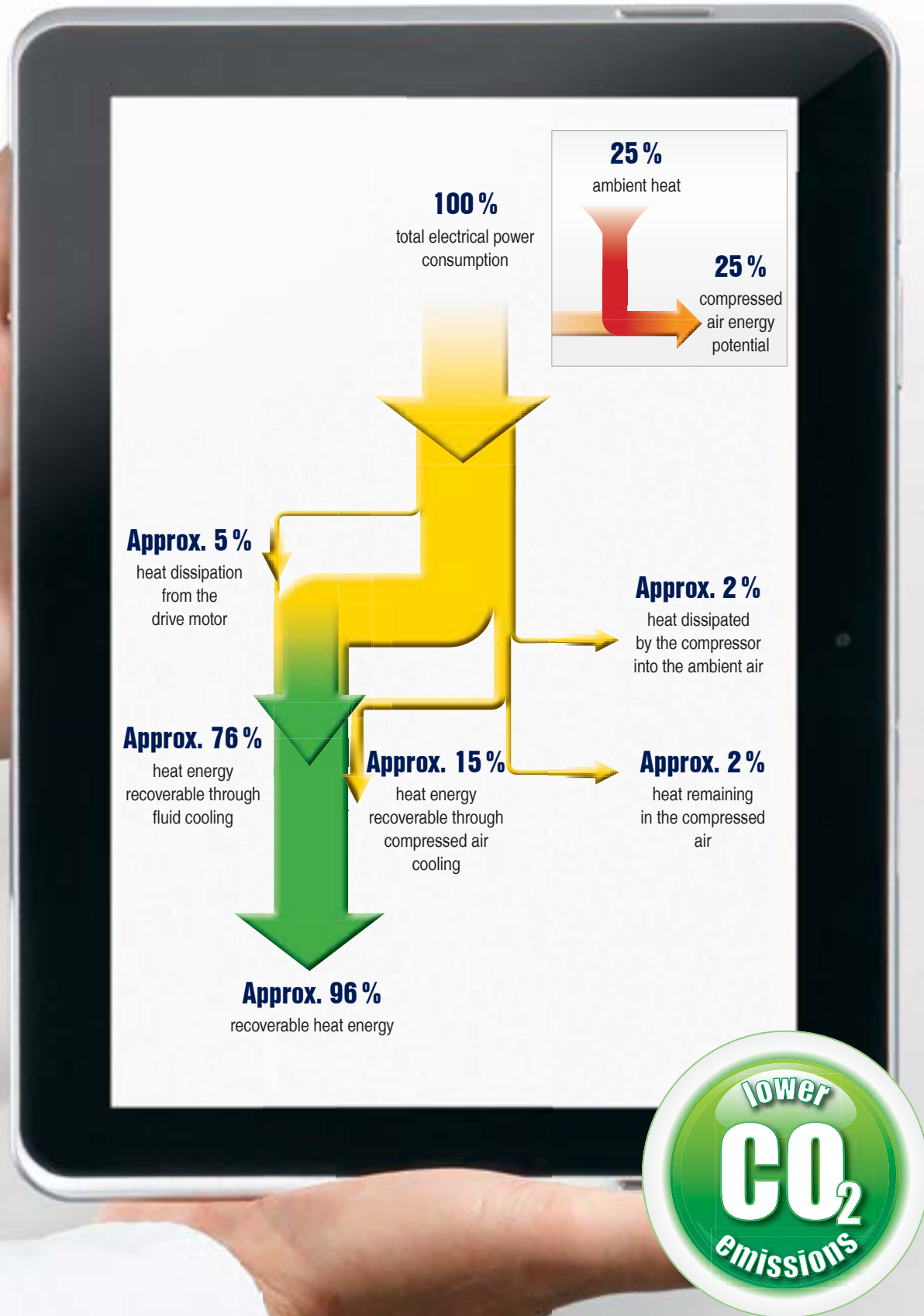

Systems for hot water usage

The integrated system comprising the plate heat exchanger, thermostatic valve and complete pipework requires no additional space in the compressor and can recover 76% of the overall power consumption of CSD/CSDX compressors by utilising the heat in the water.

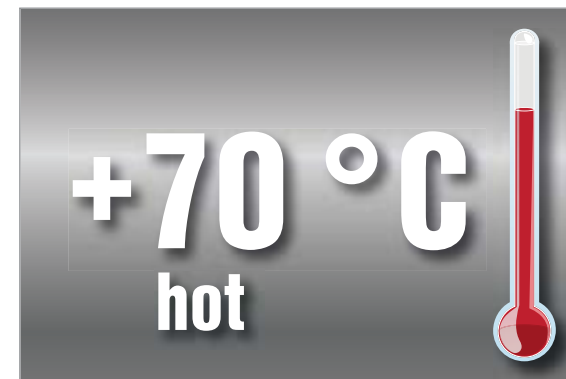

Process, heating and service water

Hot water – up to 70 °C – can be produced from reusable compressor heat via the heat exchanger system. Please contact KAESER regarding higher temperature requirements.



Space heating with warm exhaust air

It's heating made easy: thanks to the high residual thrust radial fan, exhaust (warm) air can be easily ducted away to spaces that require heating. This simple process is thermostatically controlled.



Heat recovery a win

Amazingly, 100 percent of the electrical drive energy input to a compressor is converted into heat. From that, up to 96 percent is available for heat recovery purposes. Use this potential to your advantage!



CSD 105

SIGMA 

Equipment

Complete unit

Ready-to-run, fully automatic, super-silenced, vibration damped, all panels powder coated. Suitable for use in ambient temperatures up to +45°C.

Sound insulation

Panels lined with laminated mineral wool.

Vibration dampening

Double insulated anti-vibration mountings using rubber bonded metal elements.

Airend

Genuine KAESER rotary screw, single stage airend with energy-saving SIGMA PROFILE[®] rotors and cooling fluid injection for optimised rotor cooling. 1:1 direct drive.

Drive

Direct, high-flex coupling, without gearing.

Electric motor

Premium efficiency IE3 motor, quality German manufacture, IP 55, ISO F for additional reserve; PT 100 winding temperature sensor for motor monitoring; externally lubricated bearings.

Electrical components

IP 54 control cabinet, control transformer, Siemens frequency converter, floating contacts for ventilation control.

Fluid and air flow

Dry air filter; pneumatic inlet and venting valve; cooling fluid reservoir with three-stage separator system; pressure relief valve, minimum pressure check valve, Electronic



Rotary screw airend with energy-saving SIGMA PROFILE[®] rotors

Thermal Management (ETM) and Eco fluid filter in the cooling fluid circuit; fully piped connections, flexible line connections.

Cooling

Air-cooled; separate aluminium cooler for compressed air and cooling fluid; radial fan with separate electric motor, Electronic Thermal Management (ETM).

Refrigeration dryer

CFC-free, R134a refrigerant, fully insulated, hermetically sealed refrigerant circuit, scroll refrigerant compressor with energy-saving shut-off feature, hot gas bypass control, electronic condensate drain and upstream centrifugal separator.

Heat recovery (HR)

Optionally available with integrated HR system (plate-type heat exchanger).

SIGMA CONTROL 2

"Traffic light" LED indicators show operational status at a glance, plain text display, 30 selectable languages, soft-touch keys with icons, fully automated monitoring and control. Selection of Dual, Quadro, Vario, Dynamic and continuous control as standard. Interfaces – Ethernet; additional optional communication modules for: Profibus DP, Modbus, Profinet and Devicenet; SD card slot for data recording and updates; RFID reader, web server.

Design

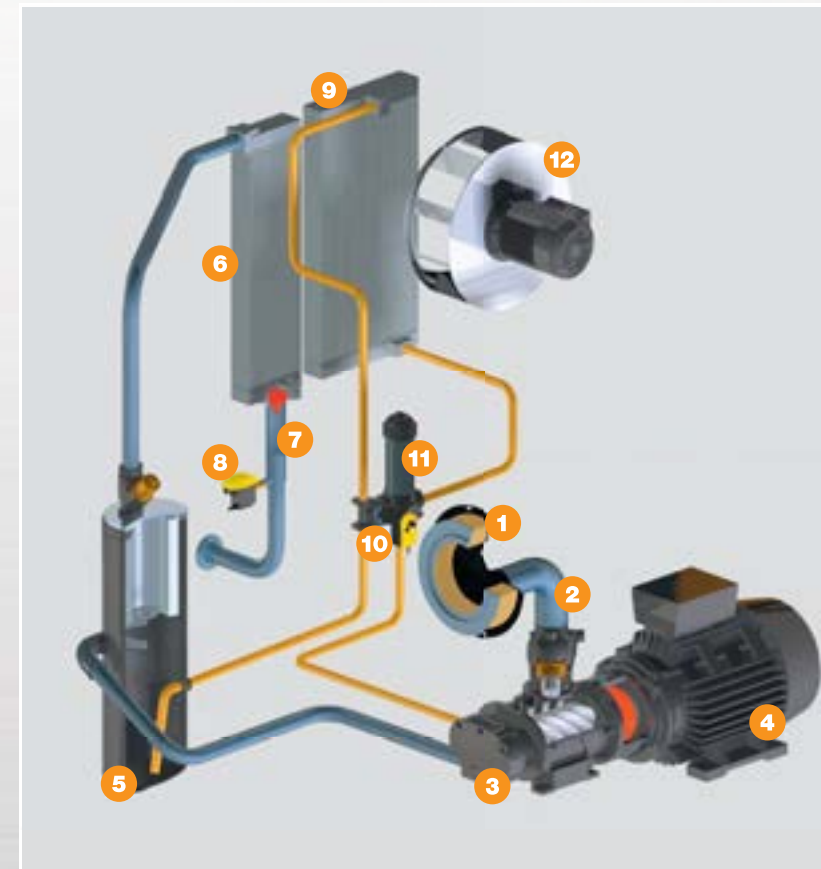

Standard version

- 1 Inlet filter
- 2 Inlet valve
- 3 Airend
- 4 Drive motor
- 5 Fluid separator tank
- 6 Compressed air aftercooler
- 7 KAESER centrifugal separator
- 8 ECO-DRAIN condensate drain
- 9 Fluid cooler
- 10 Electronic Thermal Management
- 11 Fluid filter
- 12 Radial fan



T-SFC version

- 1 Intake filter
- 2 Inlet valve
- 3 Airend
- 4 Drive motor
- 5 Fluid separator tank
- 6 Compressed air aftercooler
- 7 KAESER centrifugal separator
- 8 ECO-DRAIN condensate drain
- 9 Fluid cooler
- 10 Electronic Thermal Management
- 11 Fluid filter
- 12 Radial fan
- 13 Integrated refrigeration dryer
- 14 Switching cabinet with integrated SFC frequency converter

Technical specifications – CSD

Standard version

Model	Working pressure	FAD*) overall machine at working pressure	Max. working pressure	Rated motor power	Dimensions W x D x H	Compressed air connection	Sound pressure level **	Mass
	bar	m³/min	bar	kW				
CSD 85	7.5	8.26	8.5	45	1760 x 1110 x 1900	G 2	70	1250
	10	6.89	12					
	13	5.50	15					
CSD 105	7.5	10.14	8.5	55	1760 x 1110 x 1900	G 2	71	1290
	10	8.18	12					
	13	6.74	15					
CSD 125	7.5	12.02	8.5	75	1760 x 1110 x 1900	G 2	72	1320
	10	10.04	12					
	13	8.06	15					



T - Version with integrated refrigeration dryer (R-134a refrigerant)

Model	Working pressure	Flow rate* overall machine at working pressure	Max. working pressure	Rated motor power	Dryer power consumption	Dimensions W x D x H	Compressed air connection	Sound pressure level **	Mass
	bar	m³/min	bar	kW	kW				
CSD 85 T	7.5	8.26	8.5	45	0.8	2160 x 1110 x 1900	G 2	70	1410
	10	6.89	12						
	13	5.50	15						
CSD 105 T	7.5	10.14	8.5	55	0.8	2160 x 1110 x 1900	G 2	71	1450
	10	8.18	12						
	13	6.74	15						
CSD 125 T	7.5	12.02	8.5	75	1.1	2160 x 1110 x 1900	G 2	72	1510
	10	10.04	12		0.8				
	13	8.06	15						

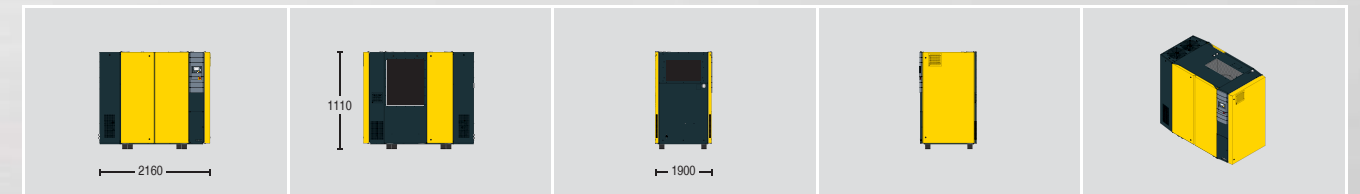

SFC - Version with variable speed drive

Model	Working pressure	Flow rate* overall machine at working pressure	Max. working pressure	Rated motor power	Dimensions W x D x H	Compressed air connection	Sound pressure level **	Mass
	bar	m³/min	bar	kW				
CSD 85 SFC	7.5	1.95 - 8.08	8.5	45	1760 x 1110 x 1900	G 2	72	1260
	10	1.48 - 6.91	12					
	13	1.07 - 5.92	15					
CSD 105 SFC	7.5	2.19 - 9.85	8.5	55	1760 x 1110 x 1900	G 2	73	1380
	10	1.90 - 8.35	12					
	13	1.36 - 6.88	15					
CSD 125 SFC	7.5	2.84 - 12.00	8.5	75	1760 x 1110 x 1900	G 2	74	1400
	10	2.05 - 10.53	12					
	13	1.79 - 8.75	15					

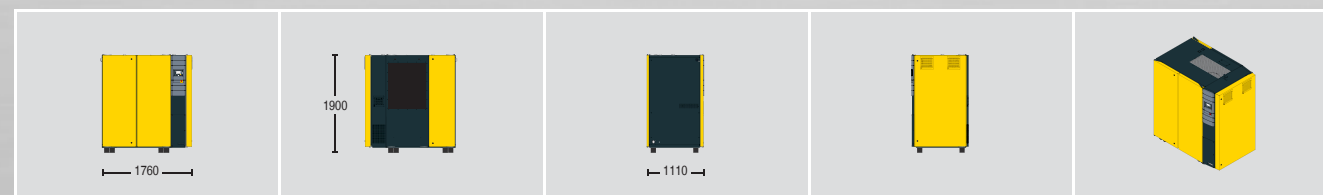

T SFC - Version with variable speed drive and integrated refrigeration dryer

Model	Working pressure	Flow rate* overall machine at working pressure	Max. working pressure	Rated motor power	Dryer power consumption	Dimensions W x D x H	Compressed air connection	Sound pressure level **	Mass
	bar	m³/min	bar	kW	kW				
CSD 85 T SFC	7.5	1.95 - 8.08	8.5	45	0.8	2160 x 1100 x 1900	G 2	71	1420
	10	1.48 - 6.91	12						
	13	1.07 - 5.92	15						
CSD 105 T SFC	7.5	2.19 - 9.85	8.5	55	0.8	2160 x 1110 x 1900	G 2	72	1540
	10	1.90 - 8.35	12						
	13	1.36 - 6.88	15						
CSD 125 T SFC	7.5	2.84 - 12.00	8.5	75	1.1	2160 x 1110 x 1900	G 2	73	1590
	10	2.05 - 10.53	12		0.8				
	13	1.79 - 8.75	15						

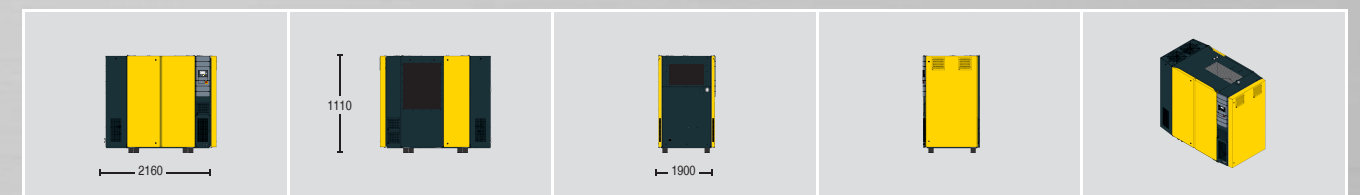

* Flow rate in accordance with ISO 1217: 2009, Annex C: Absolute intake pressure 1 bar (a), cooling and air intake temperature 20 °C

** Sound pressure level as per ISO 2151 and basic standard ISO 9614-2, operation at maximum working pressure and maximum speed; tolerance: ± 3 dB (A)

Technical specifications – CSDX

Standard version

Model	Working pressure	Flow rate* overall machine at working pressure	Max. working pressure	Rated motor power	Dimensions W x D x H	Compressed air connection	Sound pressure level **	Mass
	bar	m³/min	bar	kW				
CSDX 140	7.5	13.74	8.5	75	2110 x 1290 x 1950	G 2	71	1830
	10	11.83	12					
	13	9.86	15					
CSDX 165	7.5	16.16	8.5	90	2110 x 1290 x 1950	G 2	72	1925
	10	13.53	12					
	13	11.49	15					

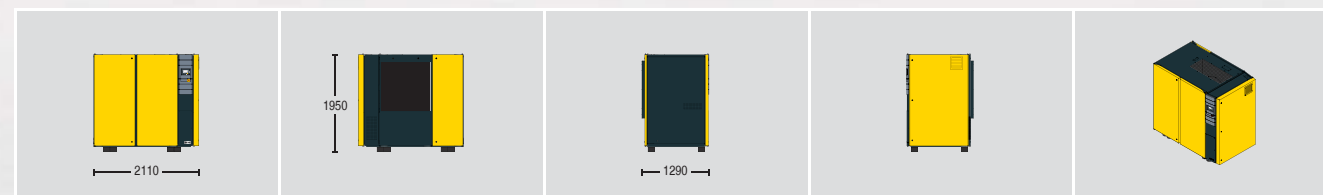

T - Version with integrated refrigeration dryer (R-134a refrigerant)

Model	Working pressure	Flow rate* overall machine at working pressure	Max. working pressure	Rated motor power	Dryer power consumption	Dimensions W x D x H	Compressed air connection	Sound pressure level **	Mass
	bar	m³/min	bar	kW	kW				
CSDX 140 T	7.5	13.74	8.5	75	1.2	2510 x 1290 x 1950	G 2	71	2045
	10	11.83	12						
	13	9.86	15						
CSDX 165 T	7.5	16.16	8.5	90	1.2	2510 x 1290 x 1950	G 2	72	2140
	10	13.53	12						
	13	11.49	15						

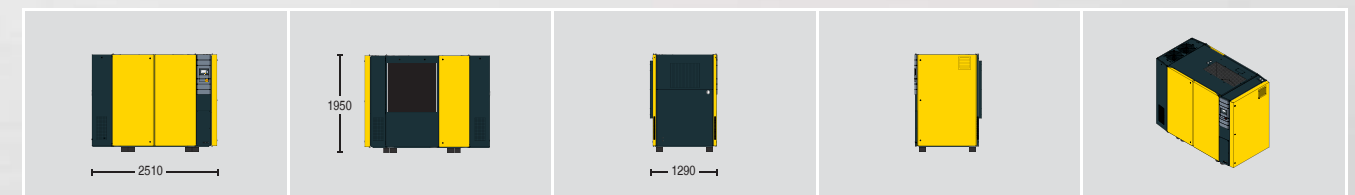

SFC - Version with variable speed drive

Model	Working pressure	Flow rate* overall machine at working pressure	Max. working pressure	Rated motor power	Dimensions W x D x H	Compressed air connection	Sound pressure level **	Mass
	bar	m³/min	bar	kW				
CSDX 140 SFC	7.5	3.39 - 13.17	8.5	75	2110 x 1290 x 1950	G 2	72	1835
	10	2.81 - 11.33	12					
	13	1.90 - 9.73	15					
CSDX 165 SFC	7.5	3.84 - 15.84	8.5	90	2110 x 1290 x 1950	G 2	73	2025
	10	3.29 - 13.84	12					
	13	2.70 - 11.70	15					

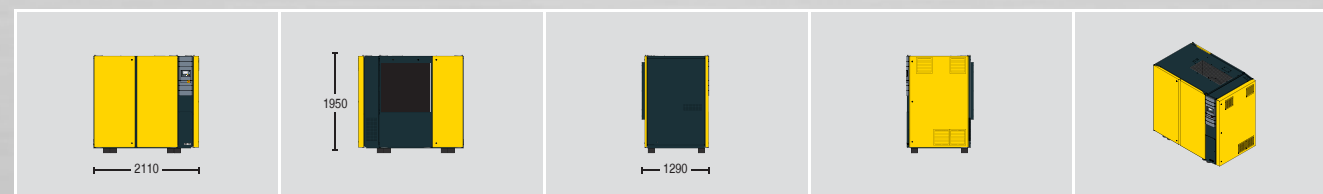

T SFC - Version with variable speed drive and integrated refrigeration dryer

Model	Working pressure	Flow rate* overall machine at working pressure	Max. working pressure	Rated motor power	Dryer power consumption	Dimensions W x D x H	Compressed air connection	Sound pressure level **	Mass
	bar	m³/min	bar	kW	kW				
CSDX 140 T SFC	7.5	3.39 - 13.17	8.5	75	1.2	2510 x 1290 x 1950	G 2	72	2050
	10	2.81 - 11.33	12						
	13	1.90 - 9.73	15						
CSDX 165 T SFC	7.5	3.84 - 15.84	8.5	90	1.2	2510 x 1290 x 1950	G 2	73	2240
	10	3.29 - 13.84	12						
	13	2.70 - 11.70	15						

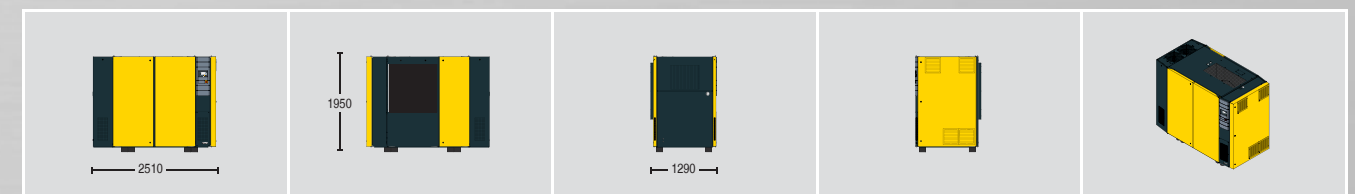

* Flow rate in accordance with ISO 1217: 2009, Annex C: Absolute intake pressure 1 bar (a), cooling and air intake temperature 20 °C

** Sound pressure level as per ISO 2151 and basic standard ISO 9614-2, operation at maximum working pressure and maximum speed; tolerance: ± 3 dB (A)

Choose the required grade of treatment according to your field of application:

Air treatment using a refrigeration dryer (pressure dew point +3°C)

Application examples: Selection of treatment classes to ISO 8573-1 (2010)

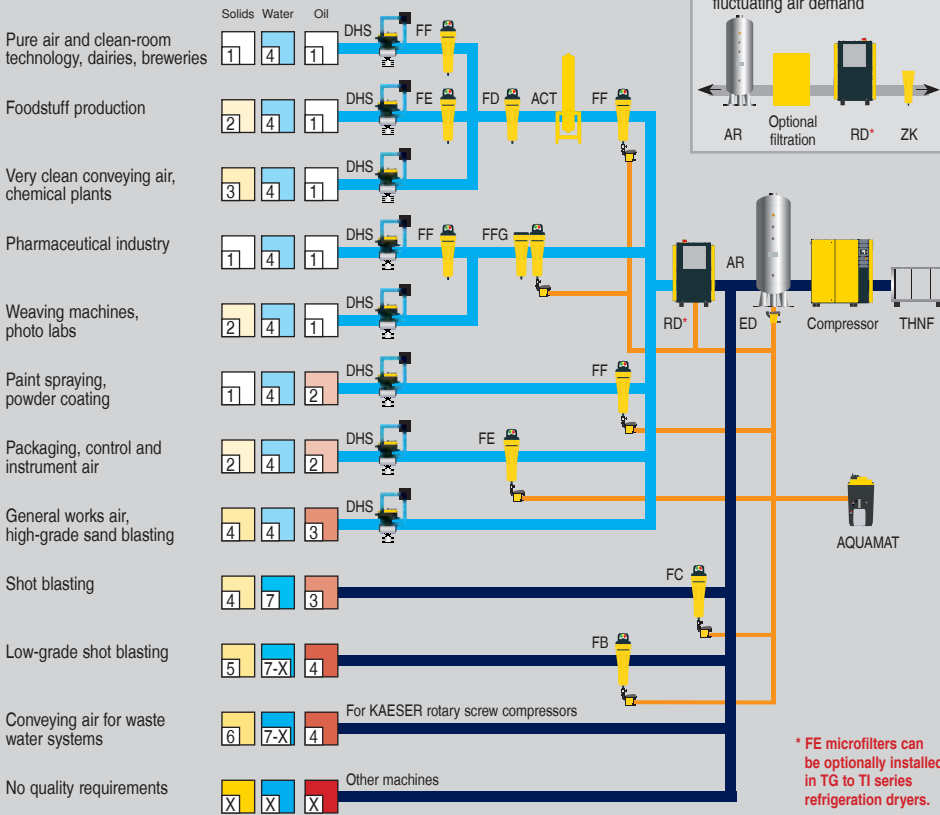

For non frost protected air systems: Compressed air treatment with a desiccant dryer (down to -70 °C pressure dew point)

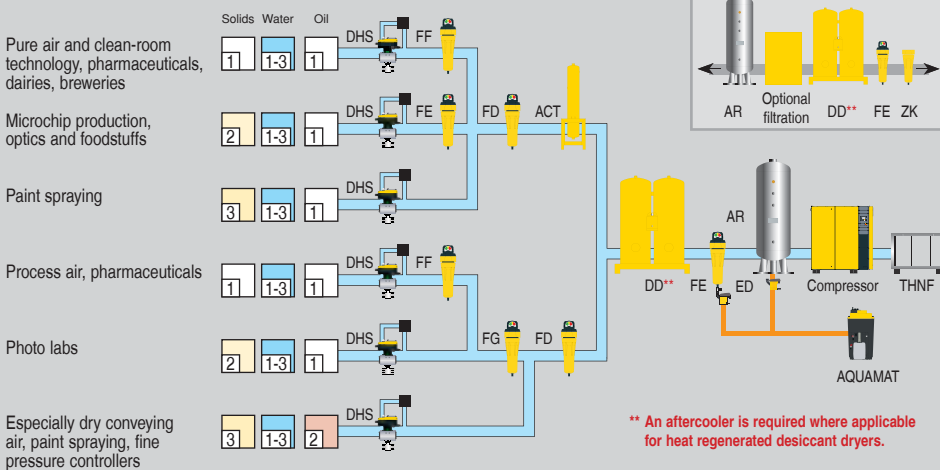

Explanation	
ACT	Activated carbon adsorber
AQUAMAT	AQUAMAT
DD	Desiccant dryer
DHS	Air-main charging system
AR	Air receiver
ED	ECO DRAIN
FB / FC	Pre-filter
FD	Particulate filter
FE / FF	Microfilter
FFG	Activated carbon and microfilter combination
FG	Activated carbon filter
RD	Refrigeration dryer
THNF	Bag filter
ZK	Centrifugal separator

Compressed air quality classes to ISO 8573-1(2010):

Solid particles / dust			
Class	Max. particle count per m ³ of a particle size with d [µm]*		
	0.1 ≤ d ≤ 0.5	0.5 ≤ d ≤ 1.0	1.0 ≤ d ≤ 5.0
0	e.g. Consult KAESER regarding pure air and cleanroom technology		
1	≤ 20,000	≤ 400	≤ 10
2	≤ 400,000	≤ 6,000	≤ 100
3	Not defined	≤ 90,000	≤ 1,000
4	Not defined	Not defined	≤ 10,000
5	Not defined	Not defined	≤ 100,000
Particle concentration C _p in mg/m ³ *			
6	0 < C _p ≤ 5		
7	5 < C _p ≤ 10		
X	C _p > 10		

Water	
Class	Pressure dew point, in °C
0	e.g. Consult KAESER regarding pure air and cleanroom technology
1	≤ -70 °C
2	≤ -40 °C
3	≤ -20 °C
4	≤ +3 °C
5	≤ +7 °C
6	≤ +10 °C
Concentration of liquid water C _w in g/m ³ *	
7	C _w ≤ 0.5
8	0.5 < C _w ≤ 5
9	5 < C _w ≤ 10
X	C _w > 10

Oil	
Class	Total oil concentration (fluid, aerosol + gaseous) [mg/m ³]*
0	e.g. Consult KAESER regarding pure air and cleanroom technology
1	≤ 0.01
2	≤ 0.1
3	≤ 1.0
4	≤ 5.0
X	> 5.0

*) At reference conditions 20°C, 1 bar(a), 0% humidity



KAESER COMPRESSORS Australia Pty. Ltd.

Locked Bag 1406 – Dandenong South – Vic. 3164

45 Zenith Road – Dandenong – Vic. 3175

Phone: +61 3 9791 5999 – Fax: +61 3 9791 5733 – E-mail: info.australia@kaeser.com – www.kaeser.com